



**NST**  
**NILES**  
**STEEL**  
**TANK**  
SINCE 1898

# MODEL # JH-60-138

## Design Notes

Code..... ASME Sec IV HLW  
 Design Pressure..... 125 psi  
 Test Pressure..... 125 psi  
 Interior.... Ultonium® Glass Lining with Microban®  
 Exterior..... Primed Painted  
 Insulation..... 2" R-12 Open cell foam  
 Supports..... Saddles  
 Capacity..... 1530 Gal. / 1688 nominal  
 Weight..... 3575 Lbs.

## Material Specifications

Heads..... Carbon Steel  
 Shell..... Carbon Steel  
 Jacket..... 24 Gauge Steel  
 Couplings..... Carbon Steel  
 Flanges..... N/A  
 Pipe..... N/A  
 Manway..... Carbon Steel

Microban® antimicrobial product protection helps prevent the growth of bacteria, mold and mildew that may affect the product. The built-in antimicrobial properties do not protect users or others from disease-causing organisms. Microban® is a registered trademark of Microban Products Company.

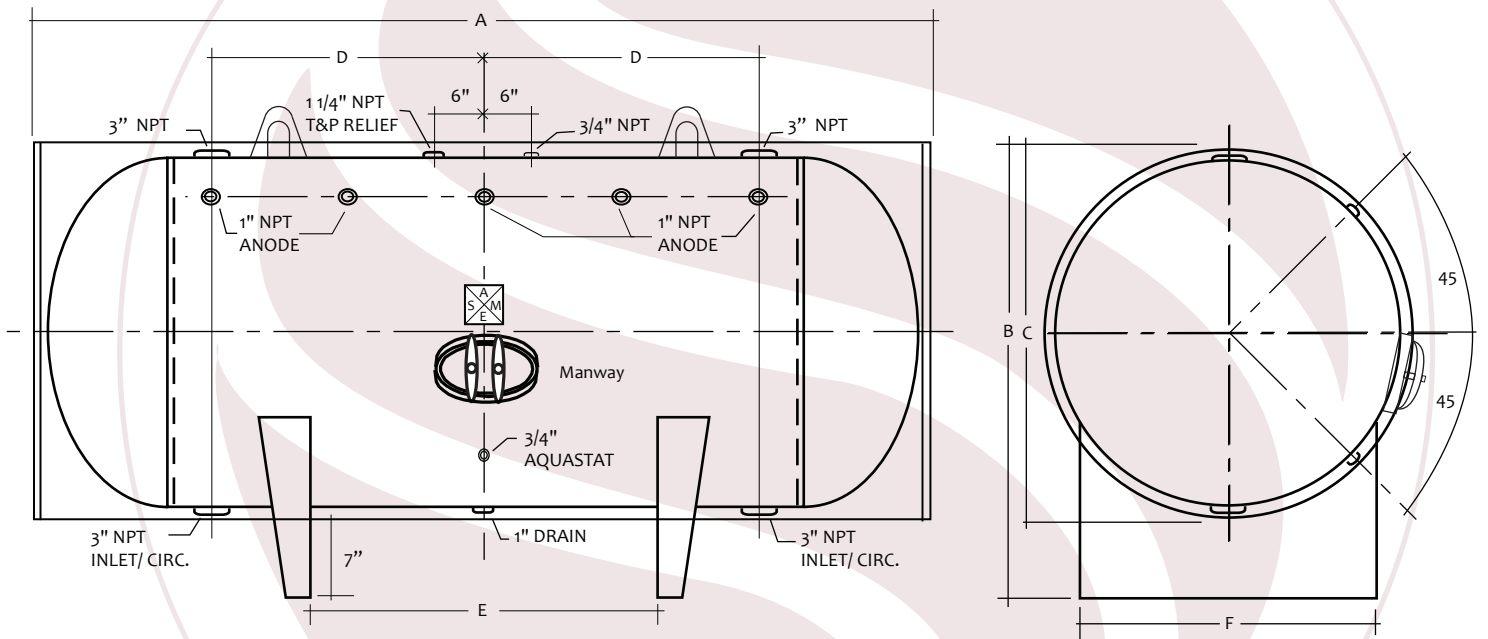

HORIZONTAL STORAGE TANK

Mark	Dimension	Remark
A	142"	Overall length
B	71"	Overall height
C	64"	Diameter
D	48"	Circulation
E	69.5"	Supports
F	52.5"	Support width

NOTES	
PROJECT	
CUSTOMER	
SCALE	Not to Scale
DATE	
CUSTOMER P.O. #	
DRAWING Rev NO.	