



# MODEL # JH-42-129

**NST**  
**NILES**  
**STEEL**  
**TANK**  
SINCE 1898

## Design Notes

Code..... ASME Sec IV HLW  
 Design Pressure..... 125 psi  
 Test Pressure..... 125 psi  
 Interior.... Ultonium® Glass Lining with Microban®  
 Exterior..... Baked Enamel Steel Jacket  
 Insulation..... 2" R-12 Open cell foam  
 Supports..... Saddles  
 Capacity..... 720 Gal. / 774 nominal  
 Weight..... 1460 Lbs.

## Material Specifications

Heads..... Carbon Steel  
 Shell..... Carbon Steel  
 Jacket..... 24 Gauge Steel  
 Couplings..... Carbon Steel  
 Flanges..... N/A  
 Pipe..... N/A  
 Manway..... Carbon Steel

Microban® antimicrobial product protection helps prevent the growth of bacteria, mold and mildew that may affect the product. The built-in antimicrobial properties do not protect users or others from disease-causing organisms. Microban® is a registered trademark of Microban Products Company.

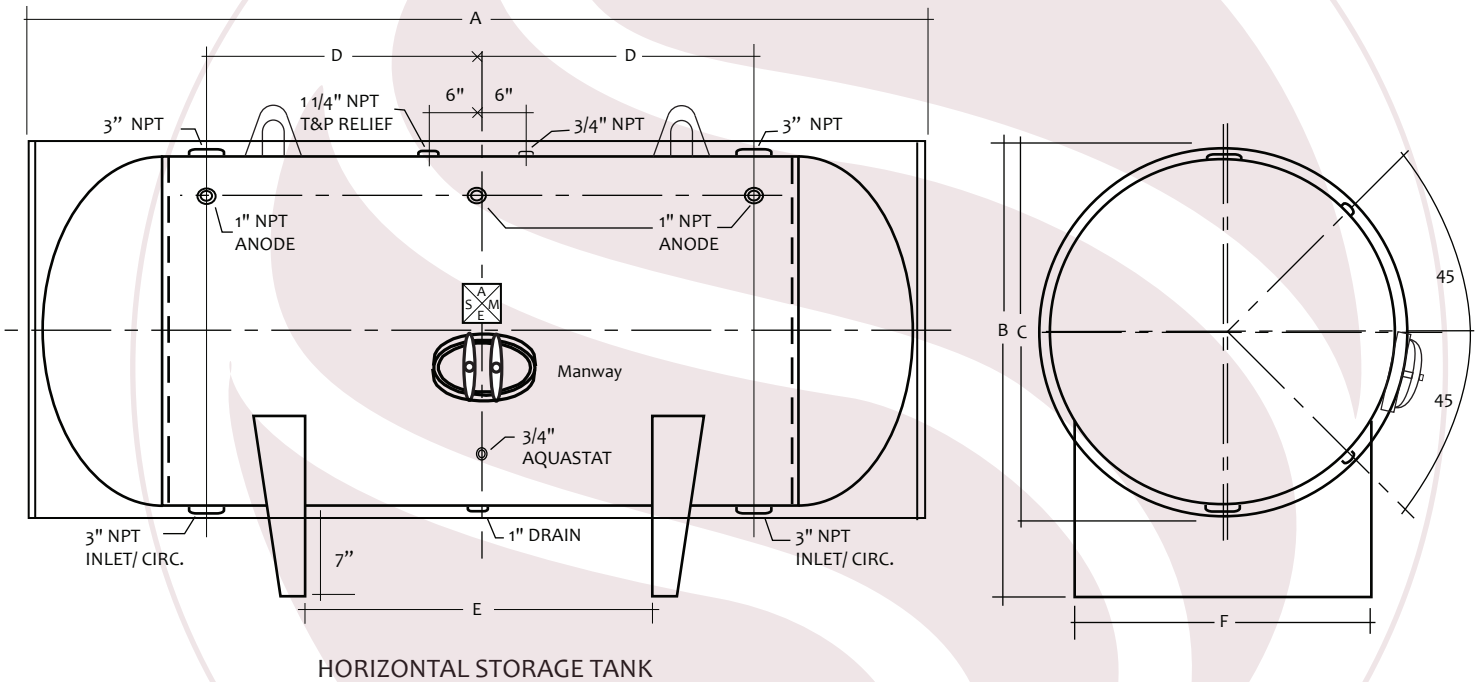

HORIZONTAL STORAGE TANK

Mark	Dimension	Remark	NOTES
A	133"	Overall length	PROJECT
B	53"	Overall height	CUSTOMER
C	46"	Diameter	SCALE Not to Scale
D	48"	Circulation	DATE
E	72"	Supports	CUSTOMER P.O. #
F	36.75"	Support width	DRAWING Rev NO.