



MODEL # JH-36-078

NST
NILES
STEEL
TANK
SINCE 1898

Design Notes

Code..... ASME Sec IV HLW
 Design Pressure..... 125 psi
 Test Pressure..... 125 psi
 Interior.... Ultonium® Glass Lining with Microban®
 Exterior..... Baked Enamel Steel Jacket
 Insulation..... 2" R-12 Open cell foam
 Supports..... Saddles
 Capacity..... 310 Gal. / 344 nominal
 Weight..... 827 Lbs.

Material Specifications

Heads..... Carbon Steel
 Shell..... Carbon Steel
 Jacket..... 24 Gauge Steel
 Couplings..... Carbon Steel
 Flanges..... N/A
 Pipe..... N/A
 Manway..... N/A

Microban® antimicrobial product protection helps prevent the growth of bacteria, mold and mildew that may affect the product. The built-in antimicrobial properties do not protect users or others from disease-causing organisms. Microban® is a registered trademark of Microban Products Company.

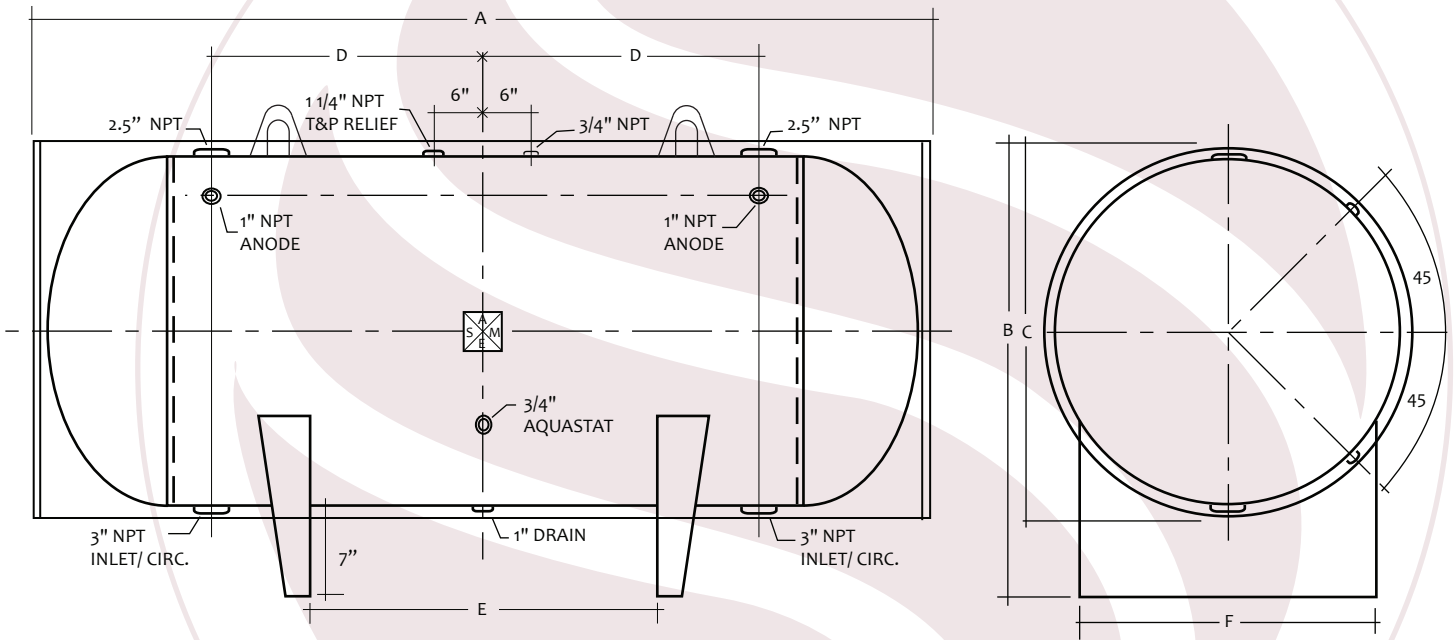

HORIZONTAL STORAGE TANK

Mark	Dimension	Remark	NOTES
A	82"	Overall length	PROJECT
B	47"	Overall height	CUSTOMER
C	40"	Diameter	SCALE Not to Scale
D	24"	Circulation	DATE
E	24"	Supports	CUSTOMER P.O. #
F	31.69"	Support width	DRAWING Rev NO.