



NST
NILES
STEEL
TANK
SINCE 1898

MODEL # BH-54-123

Design Notes

Code..... ASME Sec IV HLW
 Design Pressure..... 125 psi
 Test Pressure..... 125 psi
 Interior.... Ultonium® Glass Lining with Microban®
 Exterior..... Primed Painted
 Supports..... Saddles
 Capacity..... 1110 Gal. / 1218 nominal
 Weight..... 2124 Lbs.

Material Specifications

Heads..... Carbon Steel
 Shell..... Carbon Steel
 Couplings..... Carbon Steel
 Flanges..... N/A
 Pipe..... N/A
 Manway..... Carbon Steel

Microban® antimicrobial product protection helps prevent the growth of bacteria, mold and mildew that may affect the product. The built-in antimicrobial properties do not protect users or others from disease-causing organisms. Microban® is a registered trademark of Microban Products Company.

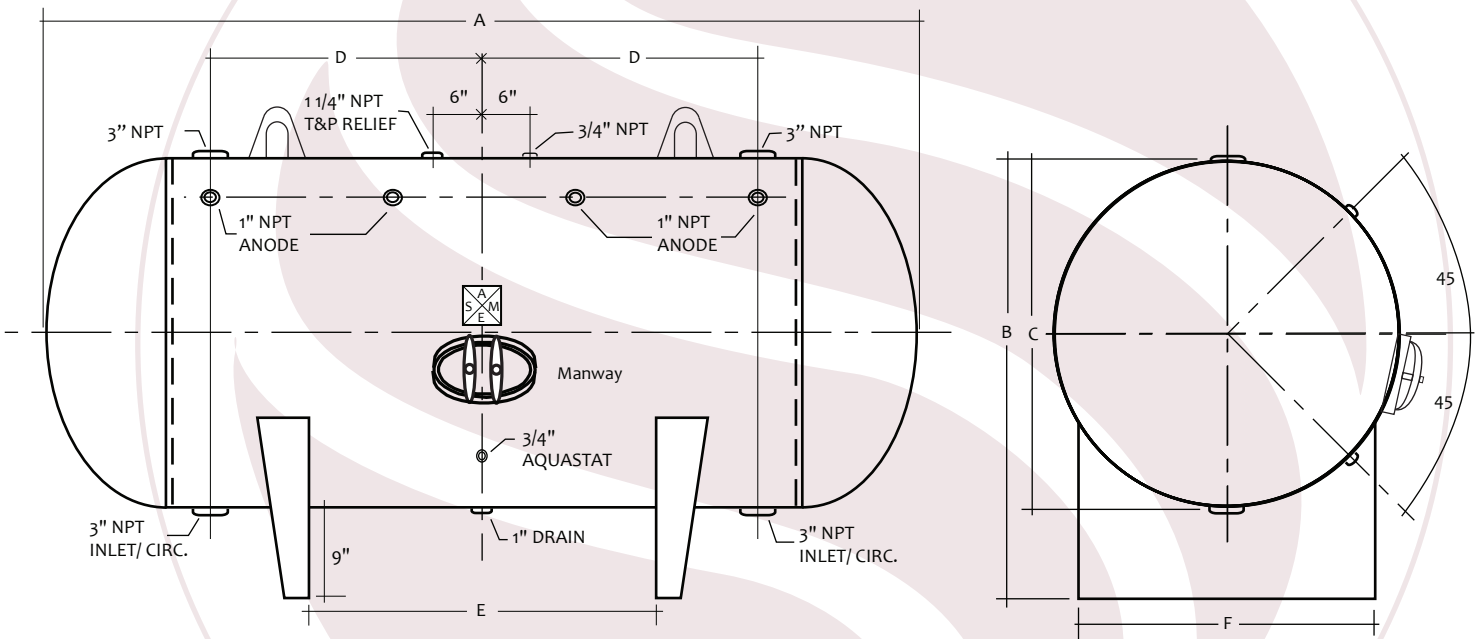

HORIZONTAL STORAGE TANK

Mark	Dimension	Remark
A	123"	Overall length
B	63"	Overall height
C	54"	Diameter
D	42"	Circulation
E	57.5"	Supports
F	47.25"	Support width

NOTES	
PROJECT	
CUSTOMER	
SCALE	Not to Scale
DATE	
CUSTOMER P.O. #	
DRAWING Rev NO.	