



NST
NILES
STEEL
TANK
SINCE 1898

MODEL # BH-60-138

Design Notes

Code..... ASME Sec IV HLW
 Design Pressure..... 125 psi
 Test Pressure..... 125 psi
 Interior..... Ultonium Glass Lining
 Exterior..... Primed Painted
 Supports..... Saddles
 Capacity..... 1530 Gal. / 1689 nominal
 Weight..... 2829 Lbs.

Material Specifications

Heads..... Carbon Steel
 Shell..... Carbon Steel
 Couplings..... Carbon Steel
 Flanges..... N/A
 Pipe..... N/A
 Manway..... Carbon Steel

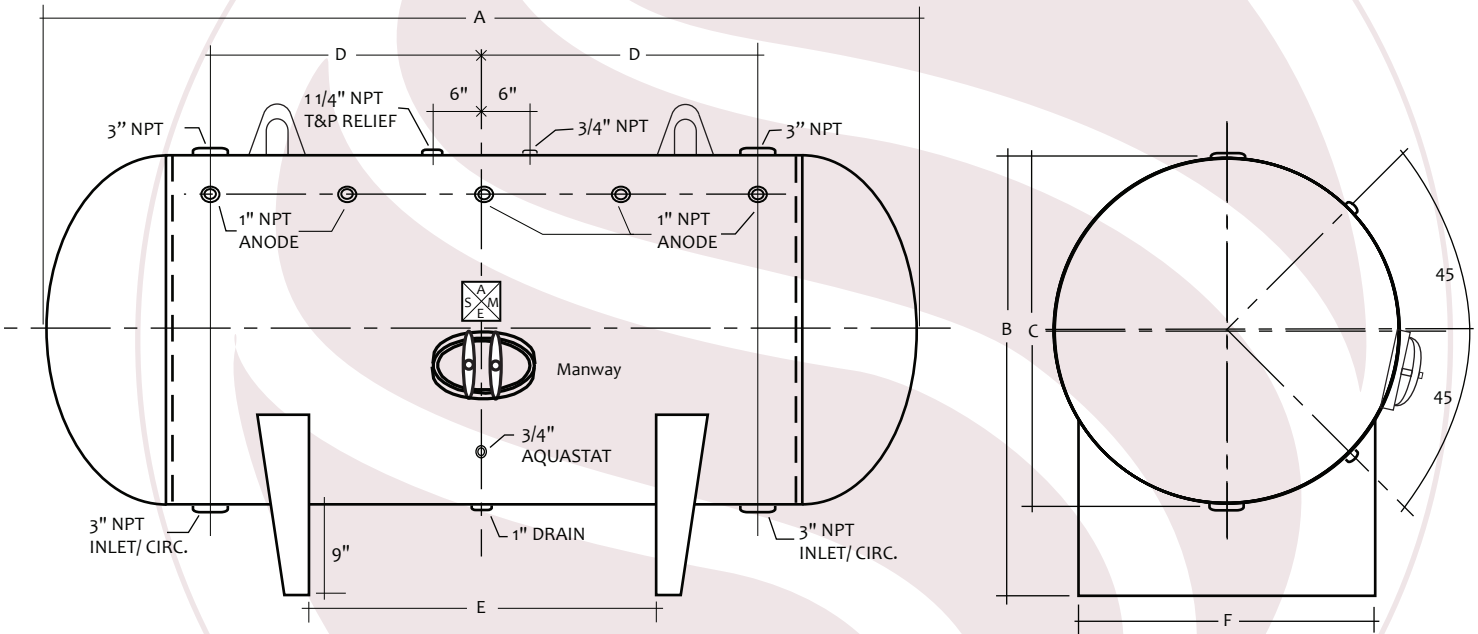

HORIZONTAL STORAGE TANK

Mark	Dimension	Remark
A	138"	Overall length
B	69"	Overall height
C	60"	Diameter
D	48"	Circulation
E	69.5"	Supports
F	52.5"	Support width

NOTES	
PROJECT	
CUSTOMER	
SCALE	Not to Scale
DATE	
CUSTOMER P.O. #	
DRAWING Rev NO.	